

**PASTIGLIA CON MORSETTI A VITE PER P.DE
IN MATERIALE TERMOPLASTICO - E27**



Confezione 100 pezzi | Box 500 pezzi



Codice Prodotto: 1361

CARATTERISTICHE

Tensione nominale: 250 Vac
Morsetti: a vite per cavi rigidi o flessibili da 0,5 ÷ 2,5 mm²

DISEGNO TECNICO

Con riserva modifiche tecniche

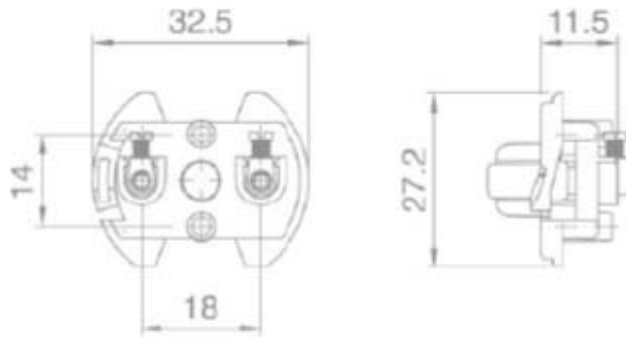

NOTES

Con riserva modifiche tecniche