

ADATTATORE

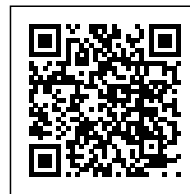

Confezione 20 pezzi | Box 100 pezzi



Codice Prodotto: 0010



CARATTERISTICHE

Adattatore: maschio E14 - Femmina GU10
Materiale: porcellana

DISEGNO TECNICO

Con riserva modifiche tecniche

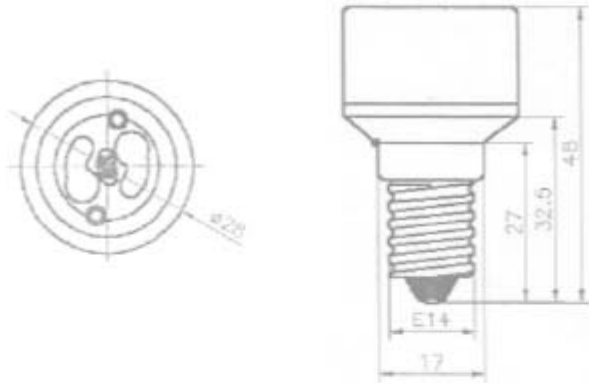

NOTES

Con riserva modifiche tecniche