

Illustrazione per l'installazione dei pannelli led

----Telaio a soffitto

1. Componenti

Telaio A *2 PCS
Telaio B *2 PCS

Accessorio a soffitto *4 PCS

Angolo in acciaio per molle *4 PCS

Angolo zincato *4 PCS

Vite del dente della macchina con cappuccio esagonale *8 PCS

M4x5 Viti autofilettanti *4 PCS

M4x25 Viti autofilettanti *4 PCS

Vite di espansione *4 PCS

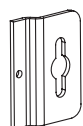

2. Assemblare i telai secondo la seguente illustrazione

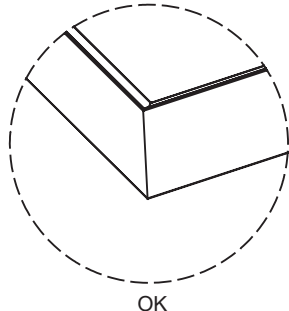
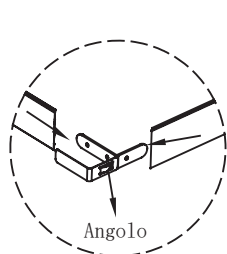

OK

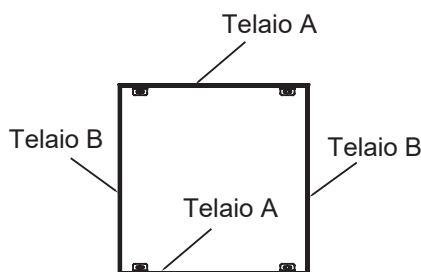

Mantieni gli stessi telai sul lato opposto

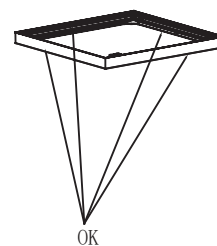

OK

3. Contrassegnare i dettagli della posizione come di seguito

ARTICOLO COMPATIBILE CON:	L*W(mm)
5074 series	1065*554
5072 series	1065*254
5073 series	465*554
5073/.../.../RI/...	465*554
5071 series	465*254
5070 series	165*254

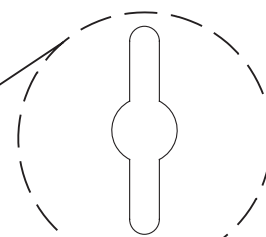
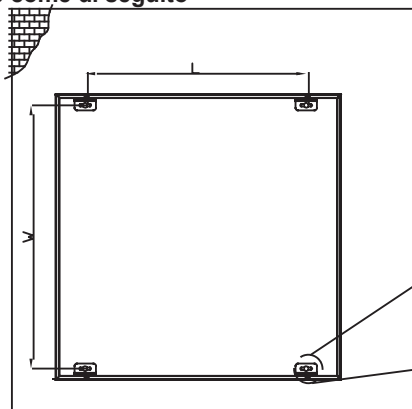

scanalatura

4. Installazione

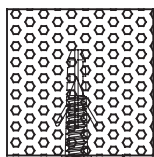

①

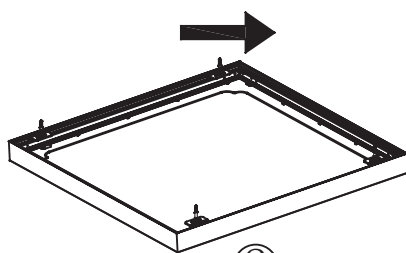

②

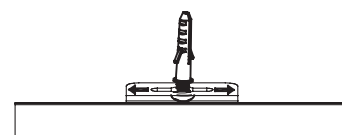

③

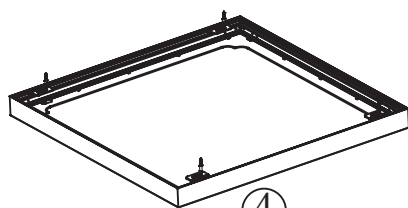

④

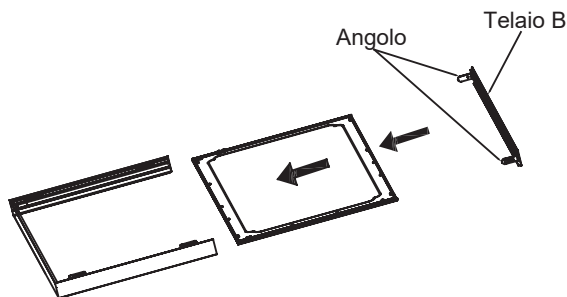

⑤

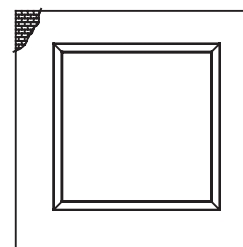

⑥

- ① Praticare 4 fori nella posizione di marcatura con viti ad espansione e viti autofilettanti (non serrare troppo).
- ② Installare il telaio assemblato sul tetto.
- ③ Spostare e fissare il telaio del soffitto (da sinistra a destra o da destra a sinistra) attraverso la scanalatura.
- ④ Serrare le viti autofilettanti M4x25.
- ⑤ Aprire il telaio B da un lato, inserire il pannello nel telaio, quindi sigillare il telaio.
- ⑥ Installazione finita.